

High Luminous Flux Density
Warm White LED Emitter
LZC-00WW00

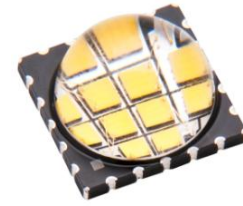

Key Features

- High Luminous Flux Density 12-die Warm White LED
- More than 40 Watt power dissipation capability
- Ultra-small foot print – 9.0mm x 9.0mm
- Industry lowest thermal resistance per package size (0.7°C/W)
- Surface mount ceramic package with integrated glass lens
- Spatial color uniformity across radiation pattern
- Excellent Color Rendering Index
- JEDEC Level 1 for Moisture Sensitivity Level
- Lead (Pb) free and RoHS compliant
- Reflow solderable (up to 6 cycles)
- Emitter available with several MCPCB options
- Full suite of TIR secondary optics family available

Typical Applications

- General lighting
- Down lighting
- Architectural lighting
- Street lighting
- Stage and Studio lighting
- Refrigeration lighting
- Portable lighting

Description

The LZC-series 12-die White LED emitter has an electrical input power dissipation capability of more than 40 Watt electrical power in an extremely small package. With a small 9.0mm x 9.0mm ultra-small footprint, this package provides exceptional luminous flux density. LED Engin's patent-pending thermally insulated phosphor layer provides a spatial color uniformity across the radiation pattern and a consistent CCT over time and temperature. The high quality materials used in the package are chosen to minimize stresses and optimize light output which results in superior reliability and lumen maintenance. The robust product design thrives in outdoor applications with high ambient temperatures and high humidity.

Part number options

Base part number

Part number	Description
LZC-00WW00-xxxx	LZC emitter
LZC-70WW00-xxxx	LZC emitter on 1 channel 1x12 Star MCPCB
LZC-C0WW00-xxxx	LZC emitter on 2 channel 2x6 Star MCPCB
LZC-E0WWT1-xxxx	LZC emitter on 1 channel 1x12 Connectorized MCPCB
LZC-F0WWT1-xxxx	LZC emitter on 1 channel 2x6 Connectorized MCPCB

Bin kit option codes

WW, Warm-White (2700K – 3500K)			
Kit number suffix	Min flux Bin	Color Bin Ranges	Description
0027	X	8A1, 8A2, 8B1, 8B2, 8A4, 8A3, 8B4, 8B3, 8D1, 8D2, 8C1, 8C2, 8D4, 8D3, 8C4, 8C3	full distribution flux; 2700K ANSI CCT bin
Y027	Y	8A1, 8A2, 8B1, 8B2, 8A4, 8A3, 8B4, 8B3, 8D1, 8D2, 8C1, 8C2, 8D4, 8D3, 8C4, 8C3	Y minimum flux bin; 2700K ANSI CCT bin
0227	X	8A2, 8B1, 8A3, 8B4, 8D2, 8C1, 8D3, 8C4	full distribution flux; 2700K ANSI CCT half bin
Y227	Y	8A2, 8B1, 8A3, 8B4, 8D2, 8C1, 8D3, 8C4	Y min flux bin; 2700K ANSI CCT half bin
0427	X	8A3, 8B4, 8D2, 8C1	full distribution flux; 2700K ANSI CCT quarter bin
Y427	Y	8A3, 8B4, 8D2, 8C1	Y min flux bin; 2700K ANSI CCT quarter bin
0030	X	7A1, 7A2, 7B1, 7B2, 7A4, 7A3, 7B4, 7B3, 7D1, 7D2, 7C1, 7C2, 7D4, 7D3, 7C4, 7C3	full distribution flux; 3000K ANSI CCT bin
Y030	Y	7A1, 7A2, 7B1, 7B2, 7A4, 7A3, 7B4, 7B3, 7D1, 7D2, 7C1, 7C2, 7D4, 7D3, 7C4, 7C3	Y min flux bin; 3000K ANSI CCT bin
0230	X	7A2, 7B1, 7A3, 7B4, 7D2, 7C1, 7D3, 7C4	full distribution flux; 3000K ANSI CCT half bin
Y230	Y	7A2, 7B1, 7A3, 7B4, 7D2, 7C1, 7D3, 7C4	Y min flux bin; 3000K ANSI CCT half bin
0430	X	7A3, 7B4, 7D2, 7C1	full distribution flux; 3000K ANSI CCT quarter bin
Y430	Y	7A3, 7B4, 7D2, 7C1	Y min flux bin; 3000K ANSI CCT quarter bin
0035	X	6A1, 6A2, 6B1, 6B2, 6A4, 6A3, 6B4, 6B3, 6D1, 6D2, 6C1, 6C2, 6D4, 6D3, 6C4, 6C3	full distribution flux; 3500K ANSI CCT bin
Y035	Y	6A1, 6A2, 6B1, 6B2, 6A4, 6A3, 6B4, 6B3, 6D1, 6D2, 6C1, 6C2, 6D4, 6D3, 6C4, 6C3	Y min flux bin; 3500K ANSI CCT bin
0235	X	6A2, 6B1, 6A3, 6B4, 6D2, 6C1, 6D3, 6C4	full distribution flux; 3500K ANSI CCT half bin
Y235	Y	6A2, 6B1, 6A3, 6B4, 6D2, 6C1, 6D3, 6C4	Y min flux bin; 3500K ANSI CCT half bin
0435	X	6A3, 6B4, 6D2, 6C1	full distribution flux; 3500K ANSI CCT quarter bin
Y435	Y	6A3, 6B4, 6D2, 6C1	Y min flux bin; 3500K ANSI CCT quarter bin

Warm White Chromaticity Groups

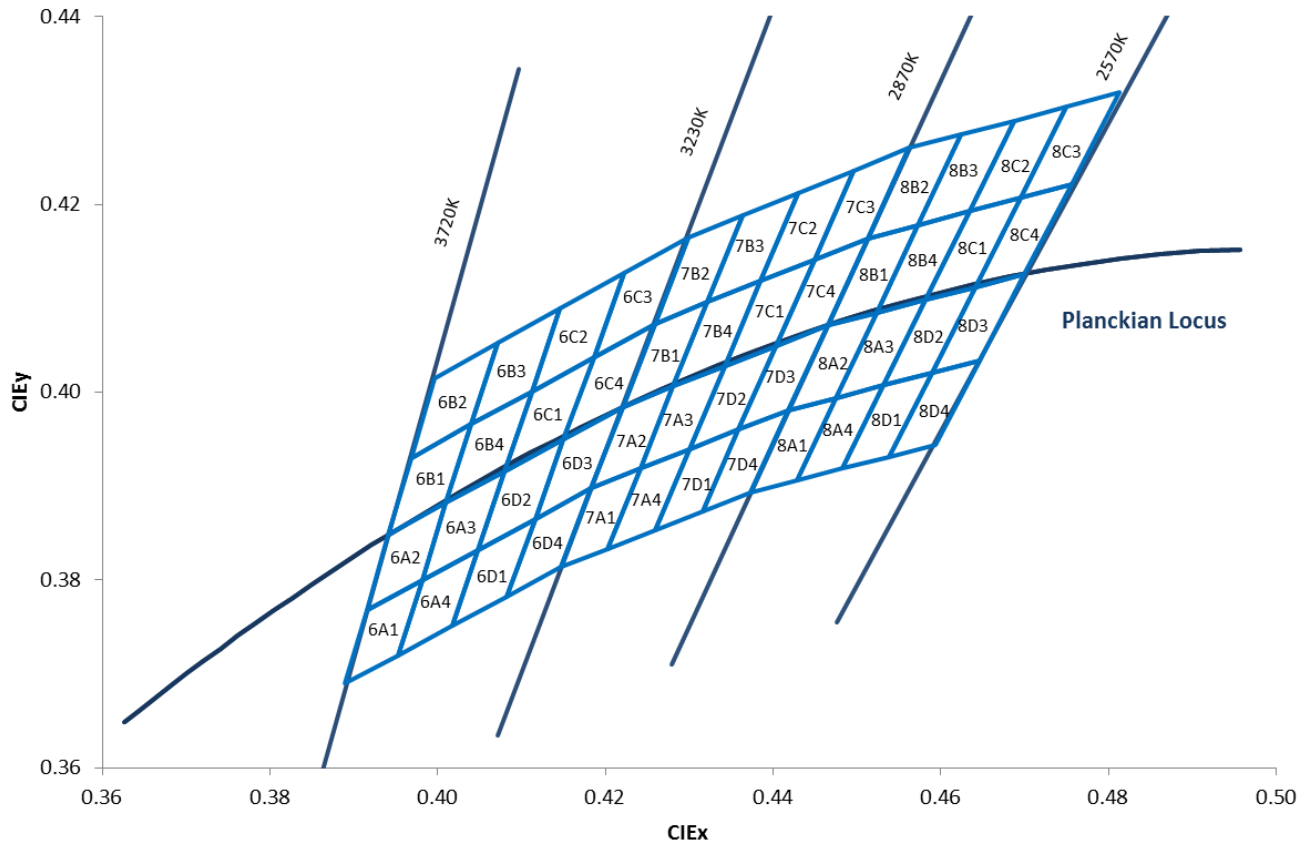

Standard Chromaticity Groups plotted on excerpt from the CIE 1931 (2°) x-y Chromaticity Diagram. Coordinates are listed below in the table.

Warm White Bin Coordinates

Bin code	CIEx	CIEy	Bin code	CIEx	CIEy	Bin code	CIEx	CIEy	Bin code	CIEx	CIEy
6A1	0.3889	0.369	6A2	0.3915	0.3768	6B1	0.3941	0.3848	6B2	0.3968	0.393
	0.3915	0.3768		0.3941	0.3848		0.3968	0.393			
	0.3981	0.38		0.401	0.3882		0.404	0.3966			
	0.3953	0.372		0.3981	0.38		0.401	0.3882			
6A4	0.3889	0.369	6A3	0.3915	0.3768	6B4	0.3941	0.3848	6B3	0.3968	0.393
	0.3953	0.372		0.3981	0.38		0.401	0.3882		0.404	0.3966
	0.3981	0.38		0.401	0.3882		0.404	0.3966		0.404	0.3966
	0.4048	0.3832		0.408	0.3916		0.4113	0.4001		0.4146	0.4089
6D1	0.4017	0.3751	6D2	0.4048	0.3832	6C1	0.408	0.3916	6C2	0.4113	0.4001
	0.4048	0.3832		0.408	0.3916		0.4113	0.4001		0.4146	0.4089
	0.4116	0.3865		0.415	0.395		0.4186	0.4037		0.4222	0.4127
	0.4082	0.3782		0.4116	0.3865		0.415	0.395		0.4186	0.4037
6D4	0.4017	0.3751	6D3	0.4048	0.3832	6C4	0.408	0.3916	6C3	0.4113	0.4001
	0.4082	0.3782		0.4116	0.3865		0.415	0.395		0.4186	0.4037
	0.4116	0.3865		0.415	0.395		0.4186	0.4037		0.4222	0.4127
	0.4183	0.3898		0.4221	0.3984		0.4259	0.4073		0.4299	0.4165
7A1	0.4147	0.3814	7A2	0.4183	0.3898	7B1	0.4221	0.3984	7B2	0.4259	0.4073
	0.4183	0.3898		0.4221	0.3984		0.4259	0.4073		0.4299	0.4165
	0.4242	0.3919		0.4281	0.4006		0.4322	0.4096		0.4364	0.4188
	0.4203	0.3833		0.4242	0.3919		0.4281	0.4006		0.4322	0.4096
7A4	0.4147	0.3814	7A3	0.4183	0.3898	7B4	0.4221	0.3984	7B3	0.4259	0.4073
	0.4242	0.3919		0.4281	0.4006		0.4322	0.4096		0.4364	0.4188
	0.4203	0.3833		0.4242	0.3919		0.4281	0.4006		0.4322	0.4096
	0.4259	0.3853		0.43	0.3939		0.4342	0.4028		0.4385	0.4119
7D1	0.4259	0.3853	7D2	0.4342	0.4028	7C1	0.4385	0.4119	7C2	0.443	0.4212
	0.43	0.3939		0.4342	0.4028		0.4385	0.4119		0.443	0.4212
	0.4359	0.396		0.4403	0.4049		0.4449	0.4141		0.4496	0.4236
	0.4316	0.3873		0.4359	0.396		0.4403	0.4049		0.4449	0.4141
7D4	0.4259	0.3853	7D3	0.43	0.3939	7C4	0.4342	0.4028	7C3	0.4385	0.4119
	0.43	0.3939		0.4342	0.4028		0.4385	0.4119		0.443	0.4212
	0.4359	0.396		0.4403	0.4049		0.4449	0.4141		0.4496	0.4236
	0.4316	0.3873		0.4359	0.396		0.4403	0.4049		0.4449	0.4141
8A1	0.4316	0.3873	8A2	0.4359	0.396	8B1	0.4403	0.4049	8B2	0.4449	0.4141
	0.4359	0.396		0.4403	0.4049		0.4449	0.4141		0.4496	0.4236
	0.4418	0.3981		0.4465	0.4071		0.4513	0.4164		0.4562	0.426
	0.4373	0.3893		0.4418	0.3981		0.4465	0.4071		0.4513	0.4164
8A4	0.4316	0.3873	8A3	0.4359	0.396	8B4	0.4403	0.4049	8B3	0.4449	0.4141
	0.4373	0.3893		0.4418	0.3981		0.4465	0.4071		0.4513	0.4164
	0.4418	0.3981		0.4465	0.4071		0.4513	0.4164		0.4562	0.426
	0.4475	0.3994		0.4523	0.4085		0.4573	0.4178		0.4624	0.4274
8D1	0.4428	0.3906	8D2	0.4475	0.3994	8C1	0.4465	0.4071	8C2	0.4513	0.4164
	0.4475	0.3994		0.4475	0.3994		0.4465	0.4071		0.4513	0.4164
	0.4532	0.4008		0.4523	0.4085		0.4523	0.4085		0.4573	0.4178
	0.4483	0.3919		0.4582	0.4099		0.4573	0.4178		0.4624	0.4274
8D4	0.4428	0.3906	8D3	0.4475	0.3994	8C4	0.4465	0.4071	8C3	0.4513	0.4164
	0.4475	0.3994		0.4475	0.3994		0.4465	0.4071		0.4513	0.4164
	0.4532	0.4008		0.4523	0.4085		0.4523	0.4085		0.4573	0.4178
	0.4483	0.3919		0.4582	0.4099		0.4573	0.4178		0.4624	0.4274
8D1	0.4483	0.3919	8D2	0.4532	0.4008	8C1	0.4582	0.4099	8C2	0.4634	0.4193
	0.4532	0.4008		0.4582	0.4099		0.4634	0.4193		0.4687	0.4289
	0.4589	0.4021		0.4641	0.4112		0.4695	0.4207		0.475	0.4304
	0.4538	0.3931		0.4589	0.4021		0.4641	0.4112		0.4695	0.4207
8D4	0.4483	0.3919	8D3	0.4532	0.4008	8C4	0.4582	0.4099	8C3	0.4634	0.4193
	0.4532	0.4008		0.4582	0.4099		0.4634	0.4193		0.4687	0.4289
	0.4589	0.4021		0.4641	0.4112		0.4695	0.4207		0.475	0.4304
	0.4538	0.3931		0.4589	0.4021		0.4641	0.4112		0.4695	0.4207
8D4	0.4538	0.3931	8D3	0.4589	0.4021	8C4	0.4641	0.4112	8C3	0.4695	0.4207
	0.4538	0.3931		0.4641	0.4112		0.4695	0.4207		0.475	0.4304
	0.4646	0.4034		0.47	0.4126		0.4756	0.4221		0.4813	0.4319
	0.4593	0.3944		0.4646	0.4034		0.47	0.4126		0.4756	0.4221
	0.4538	0.3931		0.4589	0.4021		0.4641	0.4112		0.4695	0.4207

Luminous Flux Bins

Table 1:

Bin Code	Minimum Luminous Flux (Φ_V) @ $I_F = 700\text{mA}$^[1,2] (lm)	Maximum Luminous Flux (Φ_V) @ $I_F = 700\text{mA}$^[1,2] (lm)
X	1,085	1,357
Y	1,357	1,696
Z	1,696	2,120

Notes for Table 1:

1. Luminous flux performance guaranteed within published operating conditions. LED Engin maintains a tolerance of $\pm 10\%$ on flux measurements.
2. Luminous Flux typical value is for all 12 LED dice operating concurrently at rated current.

Forward Voltage Bins

Table 2:

Bin Code	Minimum Forward Voltage (V_F) @ $I_F = 700\text{mA}$^[1,2] (V)	Maximum Forward Voltage (V_F) @ $I_F = 700\text{mA}$^[1,2] (V)
0	38.40	47.04

Notes for Table 2:

1. LED Engin maintains a tolerance of $\pm 0.04\text{V}$ for forward voltage measurements.
2. Forward Voltage is binned with 12 LED dice connected in series. The actual LED is configured with two strings of 6 dice in series.

Absolute Maximum Ratings

Table 3:

Parameter	Symbol	Value	Unit
DC Forward Current at $T_{jmax}=130C^{[1]}$	I_F	1200	mA
DC Forward Current at $T_{jmax}=150C^{[1]}$	I_F	1000	mA
Peak Pulsed Forward Current ^[2]	I_{FP}	1500	mA
Reverse Voltage	V_R	See Note 3	V
Storage Temperature	T_{stg}	-40 ~ +150	°C
Junction Temperature	T_J	150	°C
Soldering Temperature ^[4]	T_{sol}	260	°C
Allowable Reflow Cycles		6	
ESD Sensitivity ^[5]		> 8,000 V HBM Class 3B JESD22-A114-D	

Notes for Table 3:

- Maximum DC forward current (per die) is determined by the overall thermal resistance and ambient temperature. Follow the curves in Figure 10 for current derating.
- Pulse forward current conditions: Pulse Width \leq 10msec and Duty cycle \leq 10%.
- LEDs are not designed to be reverse biased.
- Solder conditions per JEDEC 020D. See Reflow Soldering Profile Figure 5.
- LED Engin recommends taking reasonable precautions towards possible ESD damages and handling the LZC-00WW00 in an electrostatic protected area (EPA). An EPA may be adequately protected by ESD controls as outlined in ANSI/ESD S6.1.

Optical Characteristics @ $T_C = 25^\circ C$

Table 4:

Parameter	Symbol	Typical	Unit
Luminous Flux (@ $I_F = 700mA^{[1]}$)	Φ_V	1650	lm
Luminous Flux (@ $I_F = 1000mA^{[1]}$)	Φ_V	2100	lm
Luminous Efficacy (@ $I_F = 350mA$)		77	lm/W
Correlated Color Temperature ^[2]	CCT	3000	K
Color Rendering Index (CRI / R9)	R_a	85	
Viewing Angle ^[3]	$2\theta_{1/2}$	110	Degrees

Notes for Table 4:

- Luminous flux typical value is for all 12 LED dice operating concurrently at rated current.
- Viewing Angle is the off-axis angle from emitter centerline where the luminous intensity is $\frac{1}{2}$ of the peak value.

Electrical Characteristics @ $T_C = 25^\circ C$

Table 5:

Parameter	Symbol	Typical	Unit
Forward Voltage (@ $I_F = 700mA^{[1]}$)	V_F	42.0	V
Forward Voltage (@ $I_F = 1000mA^{[1]}$)	V_F	43.8	V
Temperature Coefficient of Forward Voltage ^[1]	$\Delta V_F / \Delta T_J$	-33.6	mV/°C
Thermal Resistance (Junction to Case)	$R\theta_{J-C}$	0.7	°C/W

Notes for Table 5:

- Forward Voltage is binned with 12 LED dice connected in series. The actual LED is configured with two strings of 6 dice in series.

IPC/JEDEC Moisture Sensitivity Level

Table 6 - IPC/JEDEC J-STD-20.1 MSL Classification:

Level	Floor Life		Soak Requirements			
	Time	Conditions	Standard	Accelerated	Time (hrs)	Conditions
1	unlimited	≤ 30°C/ 85% RH	168 +5/-0	85°C/ 85% RH	n/a	n/a

Notes for Table 6:

- The standard soak time includes a default value of 24 hours for semiconductor manufacturer's exposure time (MET) between bake and bag and includes the maximum time allowed out of the bag at the distributor's facility.

Average Lumen Maintenance Projections

Lumen maintenance generally describes the ability of a lamp to retain its output over time. The useful lifetime for solid state lighting devices (Power LEDs) is also defined as Lumen Maintenance, with the percentage of the original light output remaining at a defined time period.

Based on long-term WHTOL testing, LED Engin projects that the LZC Series will deliver, on average, 70% Lumen Maintenance at 70,000 hours of operation at a forward current of 700 mA per die. This projection is based on constant current operation with junction temperature maintained at or below 125°C.

Mechanical Dimensions (mm)

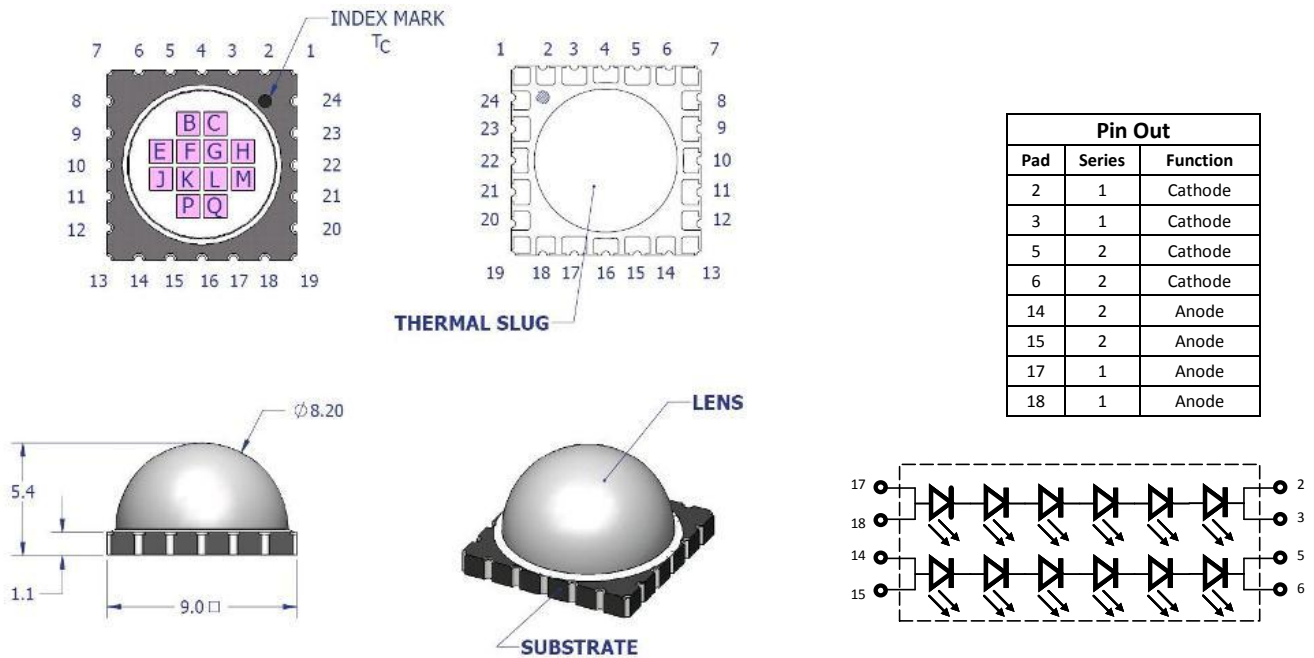

Figure 1: Package outline drawing.

Notes for Figure 1:

1. Unless otherwise noted, the tolerance = ± 0.20 mm.
2. Thermal contact pad is electrically neutral.

Recommended Solder Pad Layout (mm)

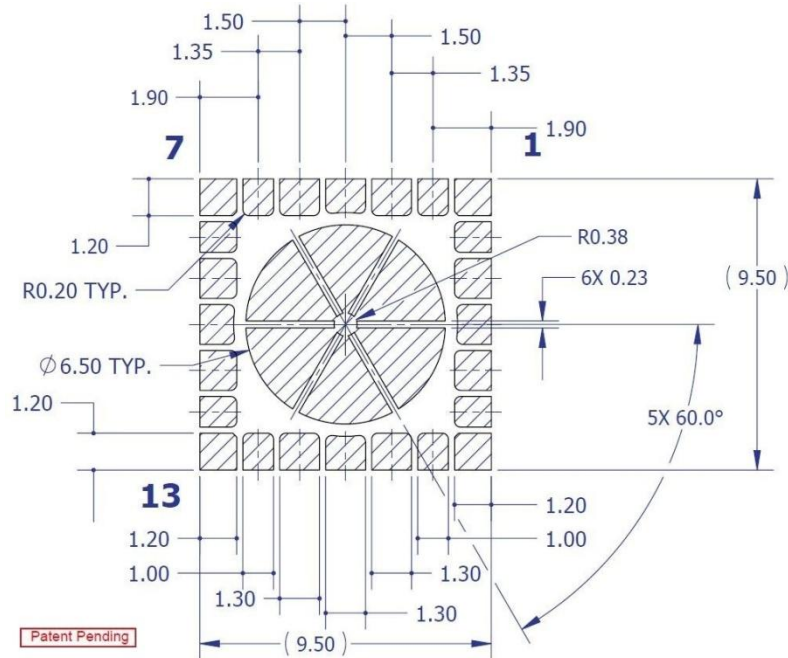

Figure 2a: Recommended solder pad layout for anode, cathode, and thermal pad.

Note for Figure 2a:

1. Unless otherwise noted, the tolerance = ± 0.20 mm.

Recommended Solder Mask Layout (mm)

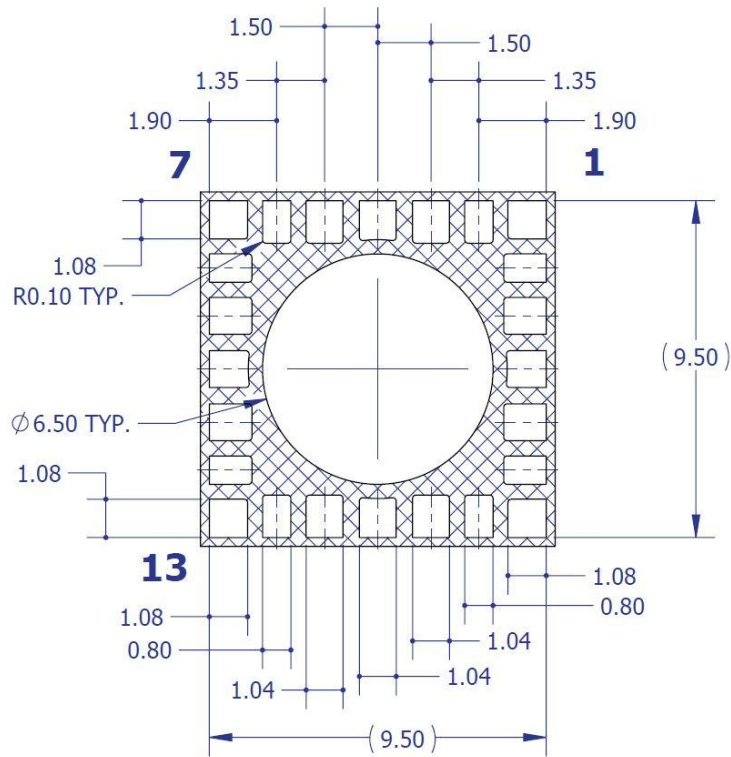

Figure 2b: Recommended solder mask opening (hatched area) for anode, cathode, and thermal pad.

Note for Figure 2b:

1. Unless otherwise noted, the tolerance = ± 0.20 mm.

Reflow Soldering Profile

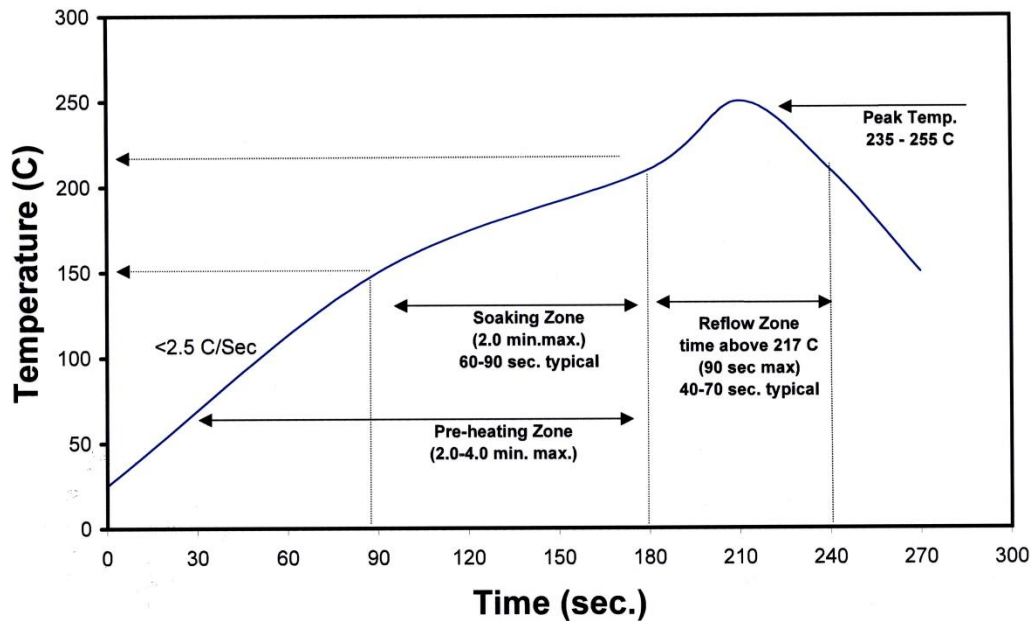

Figure 3: Reflow soldering profile for lead free soldering.

Typical Radiation Pattern

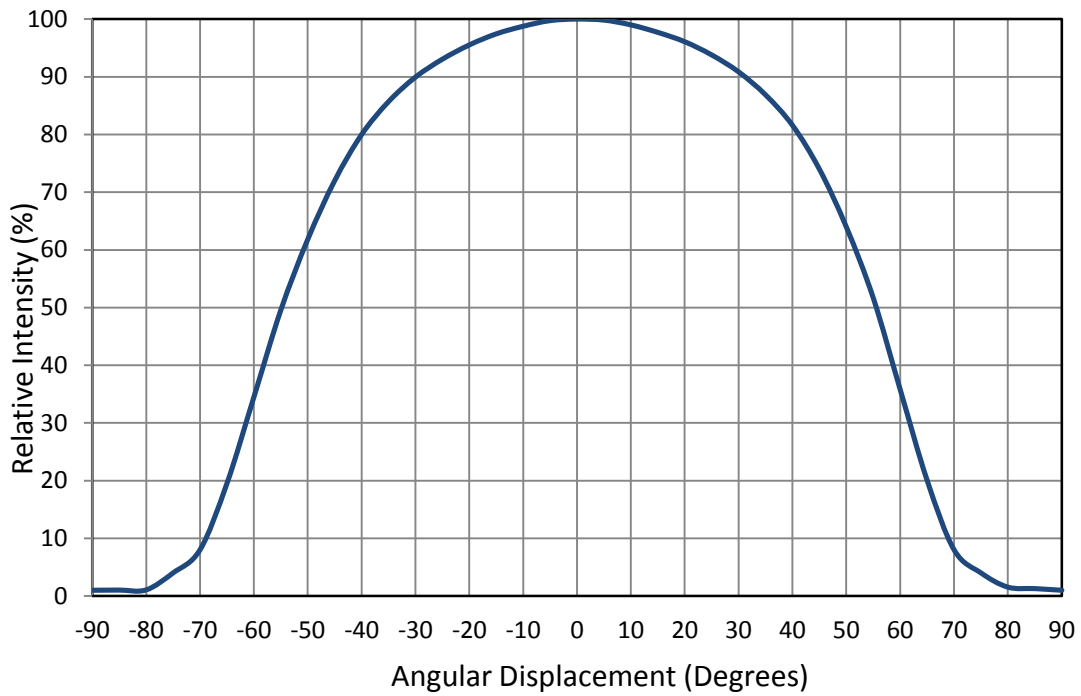

Figure 4: Typical representative spatial radiation pattern.

Typical Relative Spectral Power Distribution

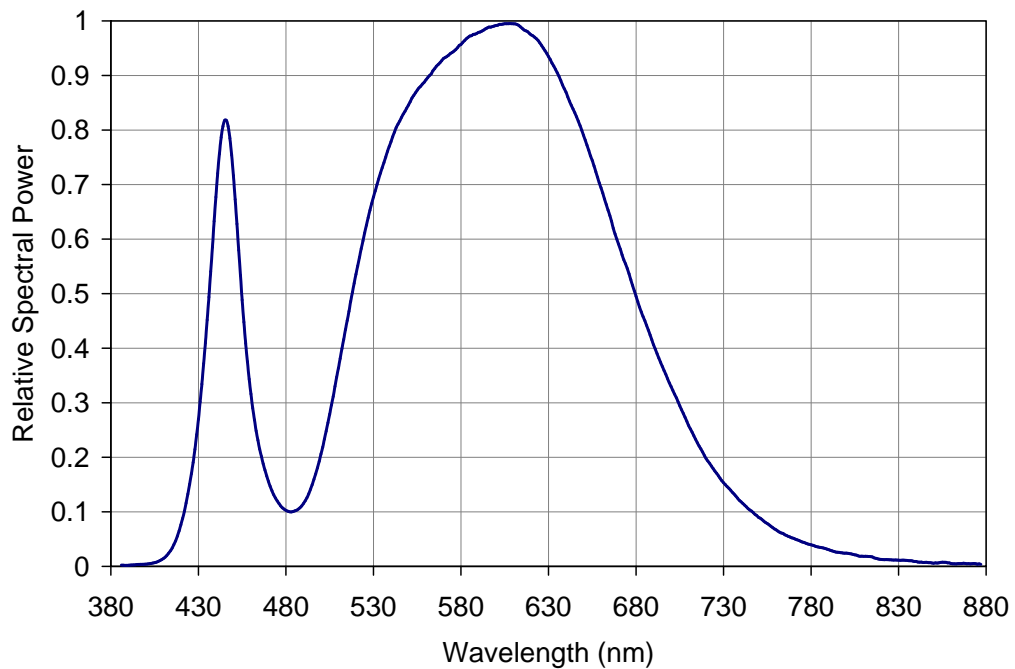

Figure 5: Typical relative spectral power vs. wavelength @ T_c = 25°C.

Typical Relative Light Output

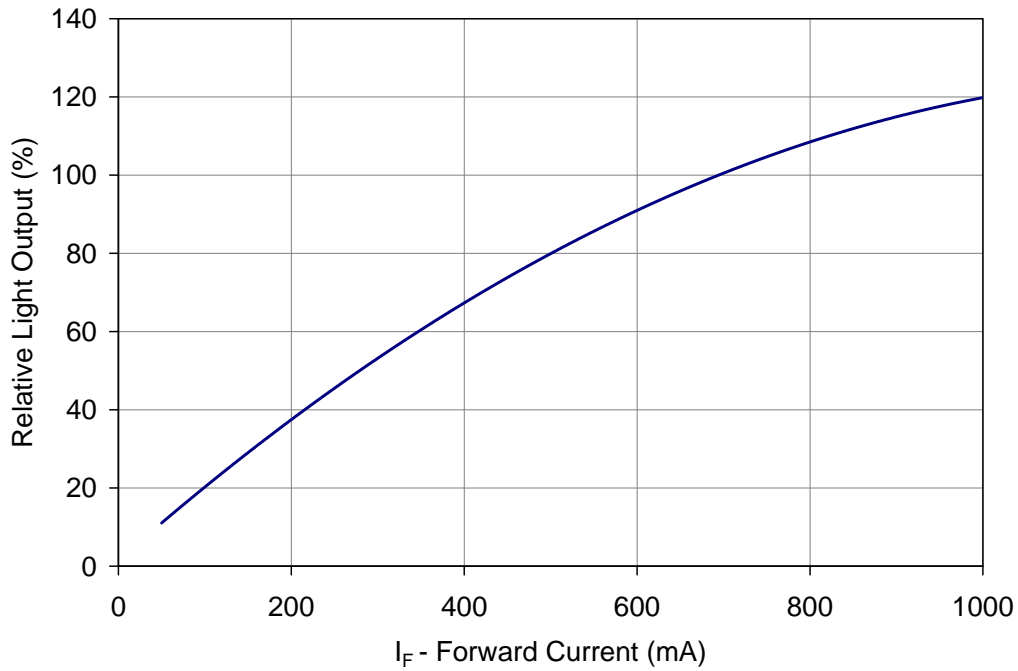

Figure 6: Typical relative light output vs. forward current @ T_c = 25°C.

Notes for Figure 6:

1. Luminous Flux typical value is for all 12 LED dice operating concurrently at rated current.

Typical Relative Light Output over Temperature

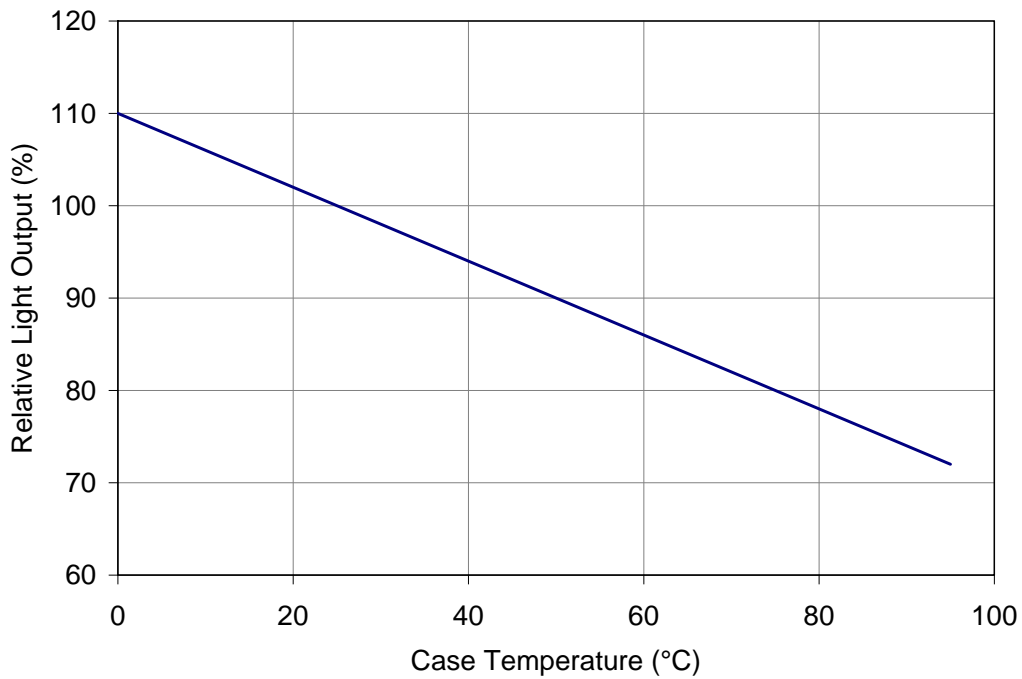

Figure 7: Typical relative light output vs. case temperature.

Notes for Figure 7:

1. Luminous Flux typical value is for all 12 LED dice operating concurrently at rated current.

Typical Forward Current Characteristics

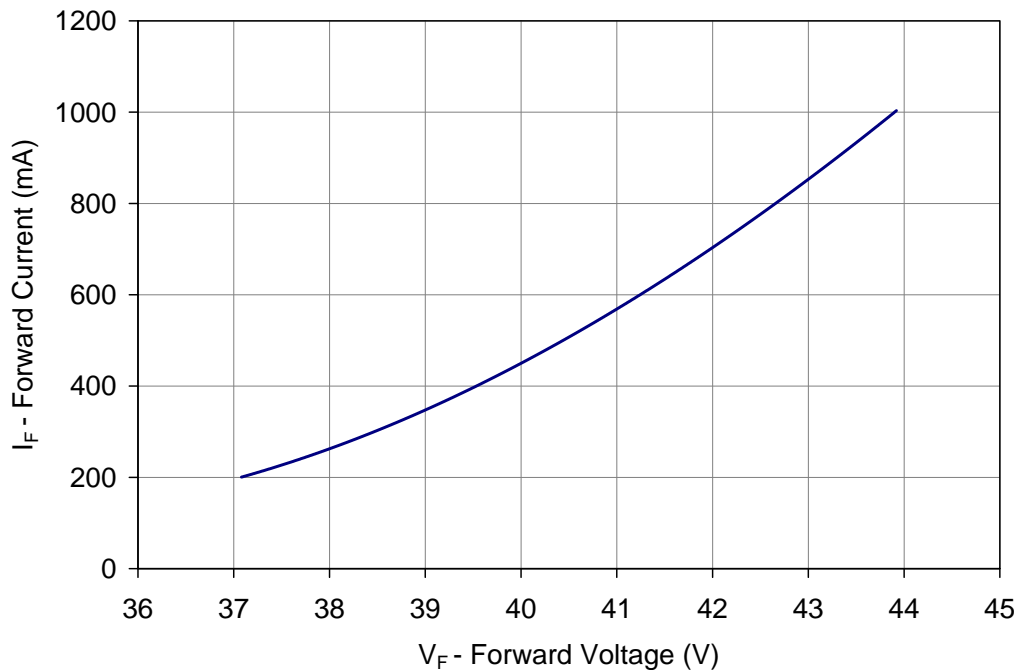

Figure 8: Typical forward current vs. forward voltage @ T_C = at 25°C.

Note for Figure 8:

1. Forward Voltage assumes 12 LED dice connected in series. The actual LED is configured with two strings of 6 dice in series.

Current De-rating

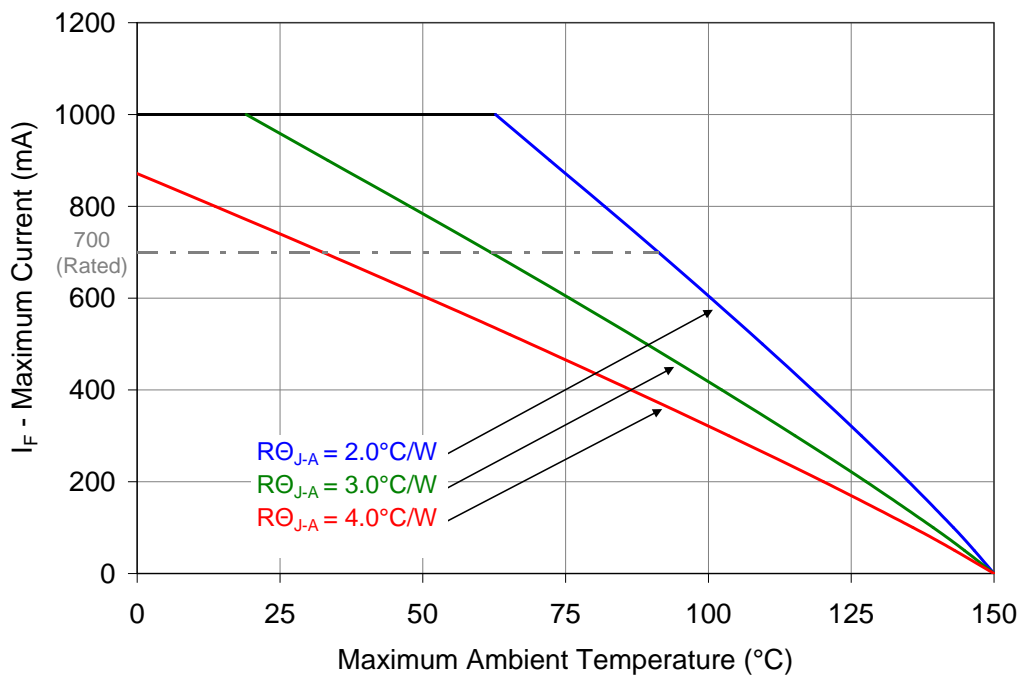

Figure 9: Maximum forward current vs. ambient temperature based on T_{J(MAX)} = 150°C.

Notes for Figure 9:

1. Maximum current assumes that all LED dice are operating concurrently at the same current.
2. R_{θ_{J-C}} [Junction to Case Thermal Resistance] for the LZC-00xx00 is typically 0.7°C/W.
3. R_{θ_{J-A}} [Junction to Ambient Thermal Resistance] = R_{θ_{J-C}} + R_{θ_{C-A}} [Case to Ambient Thermal Resistance].

Emitter Tape and Reel Specifications (mm)

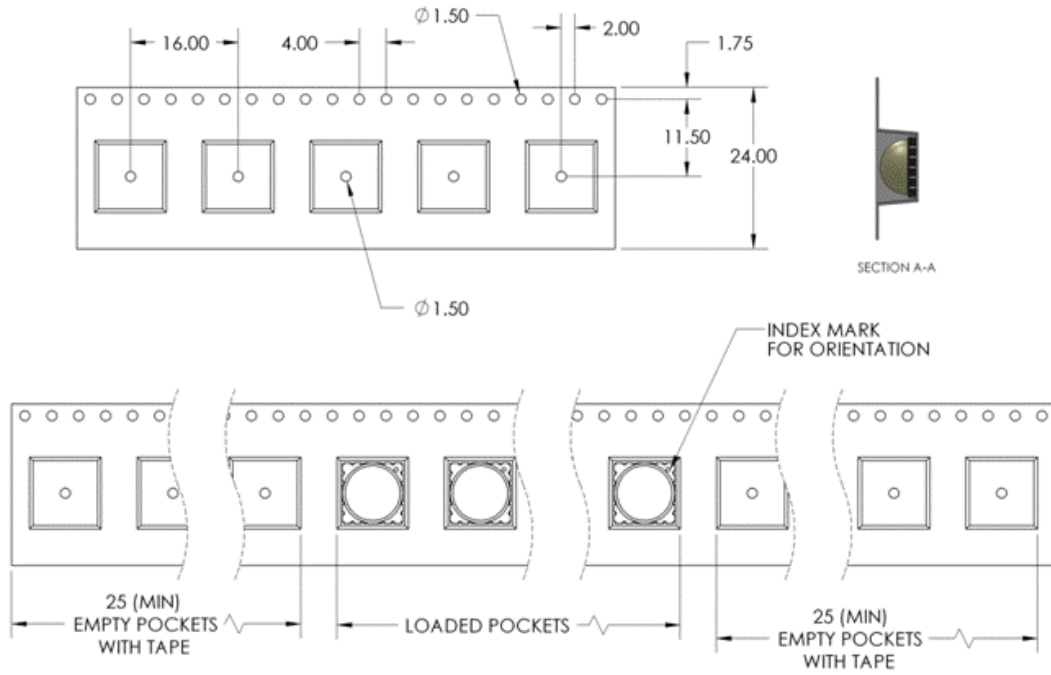

Figure 10: Emitter carrier tape specifications (mm).



Figure 11: Emitter Reel specifications (mm).

LZC MCPCB Family

Part number	Type of MCPCB	Diameter (mm)	Emitter + MCPCB Thermal Resistance (°C/W)	Typical V _f (V)	Typical I _f (mA)
LZC-7xxxxx	1-channel	28.3	0.7 + 0.6 = 1.3	42.0	700
LZC-Cxxxxx	2-channel	28.3	0.7 + 0.6 = 1.3	21.0	2 x 700
LZC-ExxxT1	1-channel (1 x 12 string)	49.5	0.7 + 0.6 = 1.3	42.0	700
LZC-FxxxT1	1-channel (2 x 6 strings)	49.5	0.7 + 0.6 = 1.3	21.0	1400

Mechanical Mounting of MCPCB

- MCPCB bending should be avoided as it will cause mechanical stress on the emitter, which could lead to substrate cracking and subsequently LED dies cracking.
- To avoid MCPCB bending:
 - Special attention needs to be paid to the flatness of the heat sink surface and the torque on the screws.
 - Care must be taken when securing the board to the heat sink. This can be done by tightening three M3 screws (or #4-40) in steps and not all the way through at once. Using fewer than three screws will increase the likelihood of board bending.
 - It is recommended to always use plastics washers in combinations with the three screws.
 - If non-taped holes are used with self-tapping screws, it is advised to back out the screws slightly after tightening (with controlled torque) and then re-tighten the screws again.

Thermal interface material

- To properly transfer heat from LED emitter to heat sink, a thermally conductive material is required when mounting the MCPCB on to the heat sink.
- There are several varieties of such material: thermal paste, thermal pads, phase change materials and thermal epoxies. An example of such material is Electrolube EHTC.
- It is critical to verify the material's thermal resistance to be sufficient for the selected emitter and its operating conditions.

Wire soldering

- To ease soldering wire to MCPCB process, it is advised to preheat the MCPCB on a hot plate of 125-150°C. Subsequently, apply the solder and additional heat from the solder iron will initiate a good solder reflow. It is recommended to use a solder iron of more than 60W.
- It is advised to use lead-free, no-clean solder. For example: SN-96.5 AG-3.0 CU 0.5 #58/275 from Kester (pn: 24-7068-7601)

LZC-7xxxxx

1 channel, Star MCPCB (1x12) Dimensions (mm)

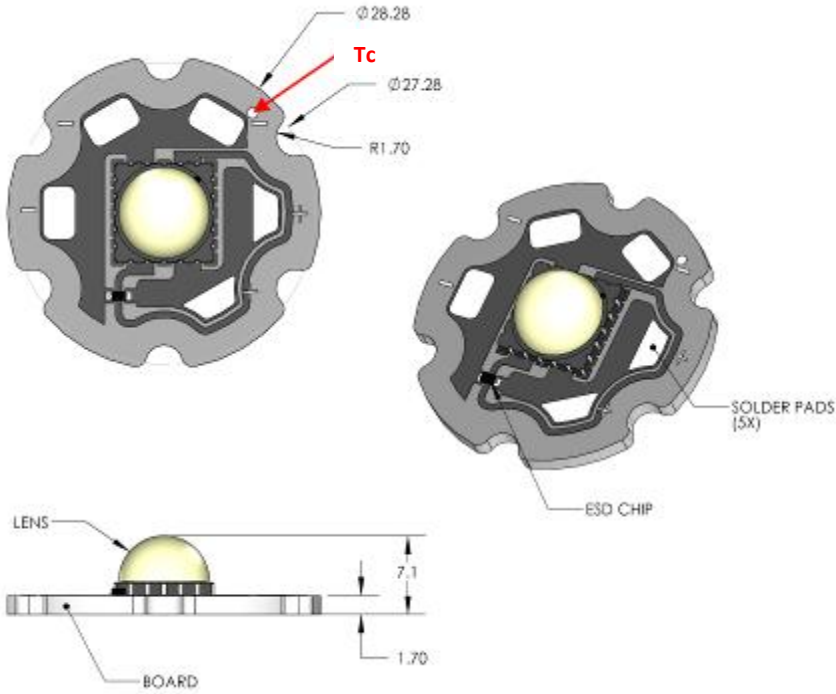

Notes:

- Unless otherwise noted, the tolerance = ± 0.2 mm.
- Slots in MCPCB are for M3 or #4-40 mounting screws.
- LED Engin recommends plastic washers to electrically insulate screws from solder pads and electrical traces.
- Electrical connection pads on MCPCB are labeled “+” for Anode and “-” for Cathode.
- LED Engin recommends using thermal interface material when attaching the MCPCB to a heatsink.
- The thermal resistance of the MCPCB is: $R_{\theta C-B}$ 0.6°C/W

Components used

MCPCB: HT04503 (Bergquist)
 ESD chips: BZX585-C51 (NXP, for 12 LED dies in series)

Pad layout			
Ch.	MCPCB Pad	String/die	Function
1	+	1/BCEFGHJ	Anode +
	-	KLMPQ	Cathode -

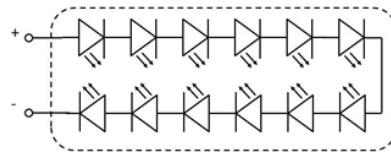

LZC-Cxxxxx

2 channel, Star MCPCB (2x6) Dimensions (mm)

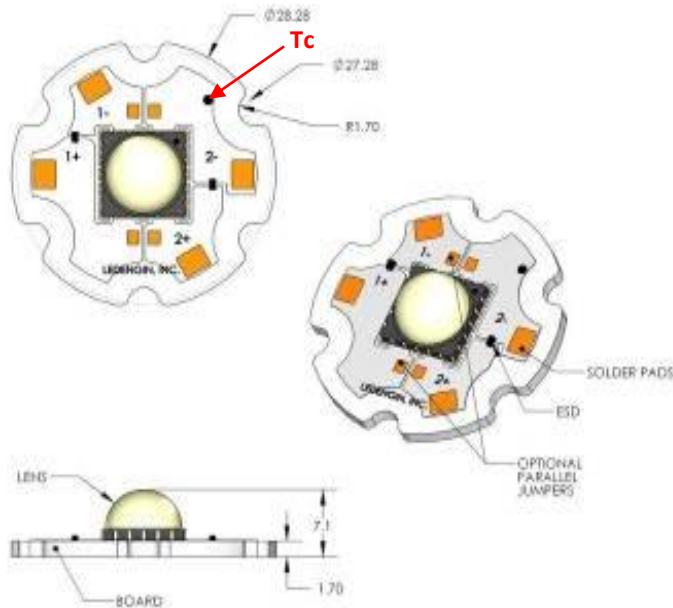

Notes:

- Unless otherwise noted, the tolerance = ± 0.2 mm.
- Slots in MCPCB are for M3 or #4-40 mounting screws.
- LED Engin recommends plastic washers to electrically insulate screws from solder pads and electrical traces.
- Electrical connection pads on MCPCB are labeled "+" for Anode and "-" for Cathode.
- LED Engin recommends thermal interface material when attaching the MCPCB to a heatsink.
- The thermal resistance of the MCPCB is: $R_{\theta C-B}$ 0.6°C/W

Components used

MCPCB: HT04503 (Bergquist)
 ESD chips: BZT52C36LP-36 (Diodes, Inc, for 6 LED dies in series)

Pad layout			
Ch.	MCPCB Pad	String/die	Function
1	+	1/BCEFGHJ	Anode +
	-	KLMPQ	Cathode -

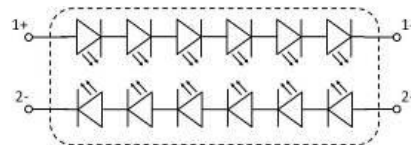

LZC-ExxxT1

1 channel, Connectorized MCPCB with Thermistor (1x12) Dimensions (mm)

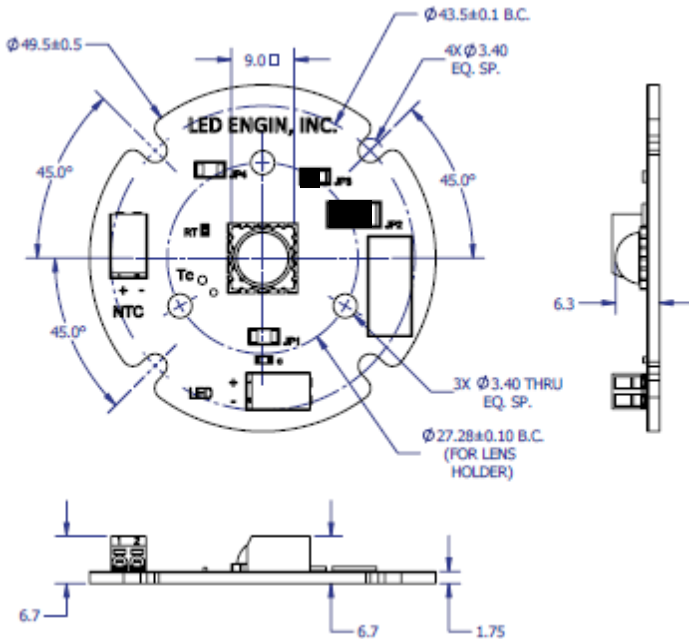

Note for Figure 1:

- Unless otherwise noted, the tolerance = ± 0.2 mm, angle = $\pm 1^\circ$
- Slots in MCPCB are for M3 or #4-40 mounting screws. Maximum torque should not exceed 1N-m (8.9 lbf-in)
- LED Engin recommends plastic washers to electrically insulate screws from solder pads and electrical traces.
- LED Engin recommends using thermally interface material when attaching the MCPCB to a heatsink
- For the connectors it is recommended to use solid wires with gauge size, 18, 20 or 22 AWG. It is recommended to strip the insulation of the wires to a length of 4-5mm. When stranded wires are used it is recommended to twist the strands at the end of the wire and use wire extraction toll to insert the wires.
- The thermal resistance of the MCPCB is: ROC-B 0.6°C/W

Components used

MCPCB:	HT04503	(Bergquist)
ESD chips:	BZX585-C51	(NXP, for 12 LED dies in series)
Thermistor:	NCP15WF104F03RC	(Murata, 100kOhm for the LZx-xxxxT1, please see www.murata.com for details on calculating the thermistor temperature)
Connectors:	00-9276-002-0-21-1-06	(AVX, poke-home)

Ch.	Pad	Emitter pin	Function
1	LED1+	14, 15	Anode
	LED1-	2, 3	Cathode
T	NTC	na	Anode
	NTC	na	Cathode

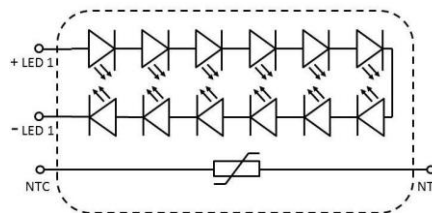

LZC-FxxxT1

1 channel, Connectorized MCPCB with Thermistor (2x6) Dimensions (mm)

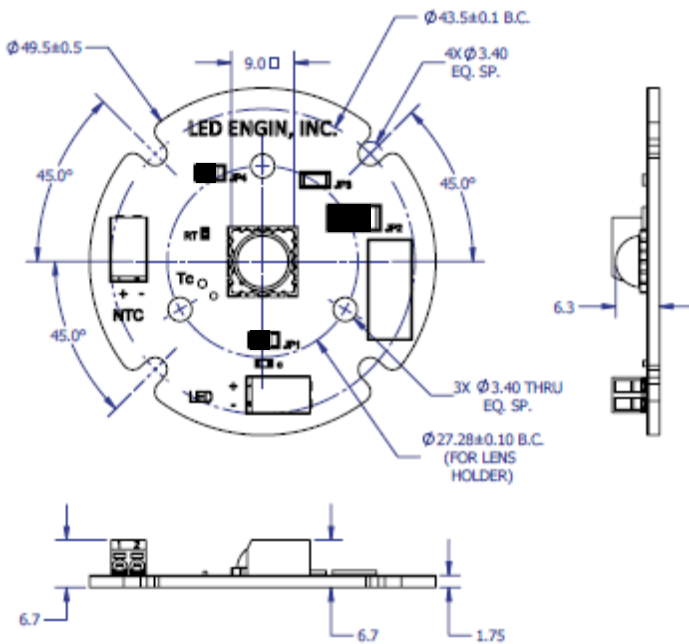

Note for Figure 1:

- Unless otherwise noted, the tolerance = ± 0.2 mm, angle = $\pm 1^\circ$
- Slots in MCPCB are for M3 or #4-40 mounting screws. Maximum torque should not exceed 1N-m (8.9 lbf-in)
- LED Engin recommends plastic washers to electrically insulate screws from solder pads and electrical traces.
- LED Engin recommends using thermally interface material when attaching the MCPCB to a heatsink
- For the connectors it is recommended to use solid wires with gauge size, 18, 20 or 22 AWG. It is recommended to strip the insulation of the wires to a length of 4-5mm. When stranded wires are used it is recommended to twists the strands at the end of the wire and use wire extraction toll to insert the wires.
- The thermal resistance of the MCPCB is: R0C-B 0.6°C/W

Components used

MCPCB:	HT04503	(Bergquist)
ESD chips:	BZT52C36LP	(NXP, for 6 LED dies in series)
Thermistor:	NCP15WF104F03RC	(Murata, 100kOhm for the LZx-xxxxT1, please see www.murata.com for details on calculating the thermistor temperature)
Connectors:	00-9276-002-0-21-1-06	(AVX, poke-home)

Ch.	Pad	Emitter pin	Function
1	LED1+	14, 15, 17, 18	Anode
	LED1-	2, 3, 5, 6	Cathode
T	NTC	na	Anode
	NTC	na	Cathode

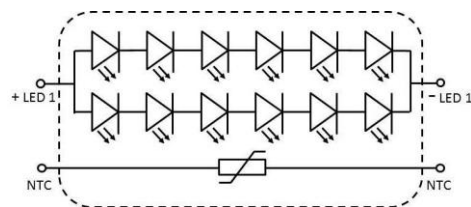

Appendix: Wire Insertion and Extraction Instructions AVX poke-home

For the AVX poke-home it is recommended to use solid wires with gauge size, 18, 20 or 22 AWG, but stranded wire can be used as well. Push the wire in and then give slight tug on the wire to confirm that it is properly engaged.

Wire Insertion Solid conductor

- Strip insulation length 4-5mm
- Insert into appropriate hole to a stop
- Inserted wire will be retained by contact

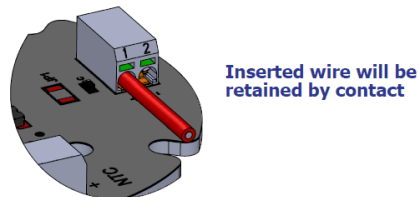
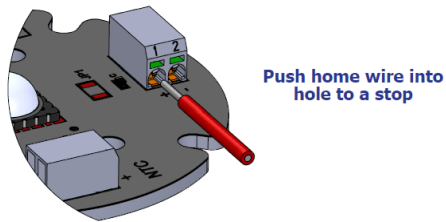

Wire Insertion Stranded wire conductor

- Twist strands together
- Insert tool into contact operation slot
- Insert wire
- Remove tool

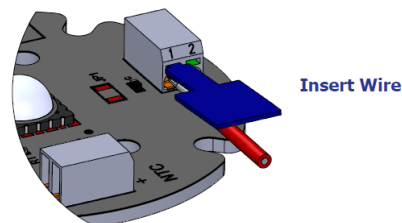
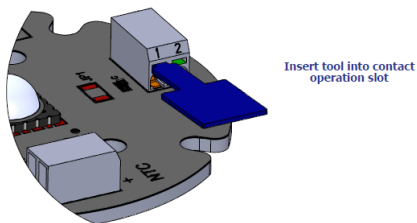
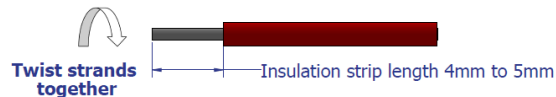

Wire extraction

- Insert tool into contact
- Extract wire
- Remove tool

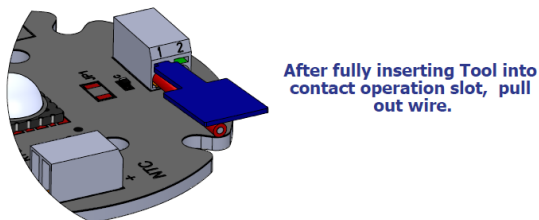

Extraction Tool References:

Thin Blade Wire Extraction Tool: AVX P/N - 0692-7670-0101-000
Miniature Precision Screw Driver, 0.047" Tip Width

Company Information

LED Engin, based in California's Silicon Valley, develops, manufactures, and sells advanced LED emitters, optics and light engines to create uncompromised lighting experiences for a wide range of entertainment, architectural, general lighting and specialty applications. LuxiGen™ multi-die emitter and secondary lens combinations reliably deliver industry-leading flux density, upwards of 5000 quality lumens to a target, in a wide spectrum of colors including whites, tunable whites, multi-color and UV LEDs in a unique patented compact ceramic package. Our LuxiTune™ series of tunable white lighting modules leverage our LuxiGen emitters and lenses to deliver quality, control, freedom and high density tunable white light solutions for a broad range of new recessed and downlighting applications. The small size, yet remarkably powerful beam output and superior in-source color mixing, allows for a previously unobtainable freedom of design wherever high-flux density, directional light is required.

LED Engin is committed to providing products that conserve natural resources and reduce greenhouse emissions.

LED Engin reserves the right to make changes to improve performance without notice.

Please contact sales@ledengin.com or (408) 922-7200 for more information.